

# Abteilung A+B

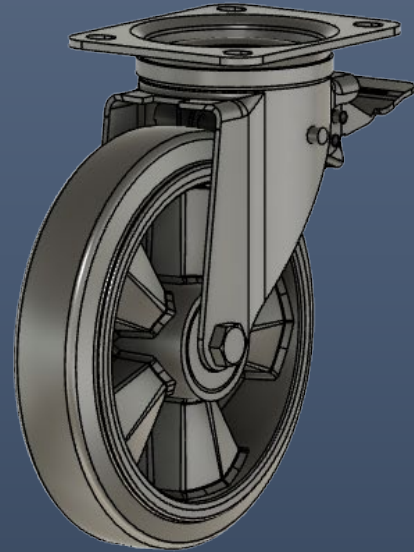

RÄDER UND ROLLEN

TRANSPORTROLLEN - INDUSTRIEROLLEN - SCHWERLASTROLLEN



**03**

Apparaterollen

**12**

Einkaufswagenrollen

**15**

Transportgeräterollen



**46**

Schwerlastrollen

**57**

Edelstahlrollen

**64**

Müllbehälterrollen



## Apparaterollen



Apparaterollen sind in medizinischen Zentren, im Einzelhandel und in der Hotellerie zu finden. Spezielles Design, verschiedene Raddurchmesser und hervorragende Laufeigenschaften sind die Merkmale dieser Gruppe.

# Leichte Apparaterollen Serie A445 434 ...

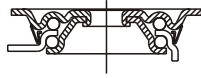

Radfelge: Polypropylen  
 Lauffläche: Thermoplast. Elastomer 95° Shore A  
 Lager: Gleitlager/ mittiges Kugellager  
 Fadenschutz: ohne/ kleiner Kunststoff Fadenschutz  
 Traglast: 50kg bis 75kg  
 Raddurchmesser: 50mm bis 75mm  
 Temperaturbereich: -20°C bis +60°C



Lenkrolle								
	mm	mm	mm	mm	mm	mm	mm	Kg
A445 434 L050G P060 A445 434 L050K P060		050	60X60	48/39X48/39	6.3	25	70	50
A445 434 L075G P060 A445 434 L075K P060		075	60X60	48/39X48/39	6.3	25	100	75



Bockrolle							
	mm	mm	mm	mm	mm	mm	Kg
A445 434 B050G P055 A445 434 B050K P055		050	55X55	44/38.5X44/38.5	6.3	70	50
A445 434 B075G P067 A445 434 B075K P067		075	67X60	48/38X48/38	6.3	100	75



Lenkrolle mit Total-Feststeller									
	mm	mm	mm	mm	mm	mm	mm	mm	Kg
A445 434 L050G P060F A445 434 L050K P060F		050	60X60	48/39X48/39	6.3	25	70	80	50
A445 434 L075G P060F A445 434 L075K P060F		075	60X60	48/39X48/39	6.3	25	100	80	75



Einbauroad mit Achsmaterial							
	mm	mm	mm	mm	Ø	Kg	
B150 434 050x19 G 08 B155 434 050x19 K 08		050	19	22	8	M6	50
B150 434 075x25 G 08 B155 434 075x25 K 08		075	25	28	8	M6	75



# Leichte Apparaterollen Serie A445 434...

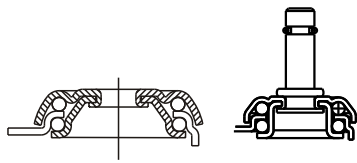

Radfelge: Polypropylen  
 Lauffläche: Thermoplast. Elastomer 95°Shore A  
 Lager: Gleitlager/ mittiges Kugellager  
 Fadenschutz: ohne/ kleiner Kunststoff Fadenschutz  
 Traglast: 50kg bis 75kg  
 Raddurchmesser: 50mm bis 75mm  
 Temperaturbereich: -20°C bis +60°C



Rückenlochlenkrolle						
	mm	mm		mm	mm	Kg
A445 434 L050G R11 A445 434 L050K R11		050	11	25	70	50
A445 434 L075G R11 A445 434 L075K R11		075	11	25	100	75



Rückenlochlenkrolle mit Total-Feststeller							
	mm	mm		mm	mm	mm	Kg
A445 434 L050G R11F A445 434 L050K R11F		050	11	25	70	80	50
A445 434 L075G R11F A445 434 L075K R11F		075	11	25	100	80	75



Rückenlochlenkrolle							
	mm	mm	mm	mm	mm	Kg	
A445 434 L050G Z11 A445 434 L050K Z11		050	11	11x31	25	70	50
A445 434 L075G Z11 A445 434 L075K Z11		075	11	11x31	25	100	75



Rückenlochlenkrolle mit Total-Feststeller								
	mm	mm	mm	mm	mm	mm	Kg	
A445 434 L050G Z11F A445 434 L050K Z11F		050	11	11x31	25	70	80	50
A445 434 L075G Z11F A445 434 L075K Z11F		075	11	11x31	25	100	80	75

# Schwere Apparaterollen Serie A455 434...

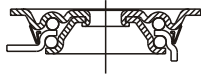

Radfelge: Polypropylen  
 Lauffläche: Thermoplast. Elastomer 95°Shore A  
 Lager: Gleitlager  
 Fadenschutz: ohne  
 Traglast: 80kg bis 100kg  
 Raddurchmesser: 80mm bis 150mm  
 Temperaturbereich: -20°C bis +60°C



Lenkrolle								
	mm	mm	mm	mm	mm	mm	mm	Kg
A450 434 L080G P077	080	77X67	61.5/56X51.5/46.5	8.5	37	111		80
A450 434 L100G P077	100	77X67	61.5/56X51.5/46.5	8.5	37	135		100
A455 434 L125G P077	125	77X67	61.5/56X51.5/46.5	8.5	40	160		100
A455 434 L125G P095	125	95X70	75X50	11	40	160		100
A455 434 L150G P077	150	77X67	61.5/56X51.5/46.5	8.5	40	185		100



Bockrolle							
	mm	mm	mm	mm	mm	mm	Kg
A455 434 B080G P077	080	77X67	61.5/56X51.5/46.5	8.5		111	80
A455 434 B100G P077	100	77X67	61.5/56X51.5/46.5	8.5		135	100
A455 434 B125G P077	125	77X67	61.5/56X51.5/46.5	8.5		160	100
A455 434 B125G P095	125	95X70	75X50	11		160	100
A455 434 B150G P077	150	77X67	61.5/56X51.5/46.5	8.5		185	100





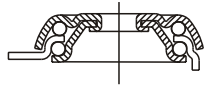

Lenkrolle mit Total-Feststeller									
	mm	mm	mm	mm	mm	mm	mm	mm	Kg
A455 434 L080G P077	080	77X67	61.5/56X51.5/46.5	8.5	37	111	132		80
A455 434 L100G P077	100	77X67	61.5/56X51.5/46.5	8.5	37	135	132		100
A455 434 L125G P077	125	77X67	61.5/56X51.5/46.5	8.5	40	160	132		100
A455 434 L125G P097	125	95X70	75X50	11	40	160	132		100
A455 434 L125G P077	150	77X67	61.5/56X51.5/46.5	8.5	40	185	132		100

# Schwere Apparaterollen Serie A455 434...









Radfelge: Polypropylen  
 Lauffläche: Thermoplast. Elastomer 95°Shore A  
 Lager: Gleitlager  
 Fadenschutz: ohne  
 Traglast: 80kg bis 100kg  
 Raddurchmesser: 80mm bis 150mm  
 Temperaturbereich: -20°C bis +60°C









Rückenlochlenkrolle					
	mm	mm	mm	mm	Kg
A455 434 L080G R11	080	11	37	111	80
A455 434 L100G R11	100	11	37	135	100
A455 434 L125G R11	125	11	40	160	100
A455 434 L150G R11	150	11	40	185	100



Rückenlochlenkrolle mit Total-Feststeller						
	mm	mm	mm	mm	mm	Kg
A455 434 L080G R11F	080	11	37	111	132	80
A455 434 L100G R11F	100	11	37	135	132	100
A455 434 L125G R11F	125	11	40	160	132	100
A455 434 L150G R11F	150	11	40	185	132	100



Einbaurad mit Achsmaterial						
	mm	mm	mm	mm	Ø	Kg
B150 434 080x32 G 12	080	32	36	12	M8	80
B150 434 100x32 G 12	100	32	36	12	M8	100
B150 434 125x32 G 12	125	32	36	12	M8	100
B150 434 150x12 G 12	150	32	36	12	M8	100

# Schwere Apparaterollen Serie A455 434...

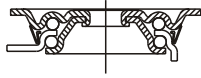

Radfelge: Polypropylen  
 Lauffläche: Thermoplast. Elastomer 95°Shore A  
 Lager: mittiges Kugellager  
 Fadenschutz: großer Kunststoff Fadenschutz  
 Traglast: 80kg bis 100kg  
 Raddurchmesser: 80mm bis 150mm  
 Temperaturbereich: -20°C bis +60°C



Lenkrolle		mm	mm	mm	mm	mm	mm	mm	Kg
A455 434 L080K P077		080	77X67	61.5/56X51.5/46.5	8.5	37	111		80
A455 434 L100K P077		100	77X67	61.5/56X51.5/46.5	8.5	37	135		100
A455 434 L125K P077		125	77X67	61.5/56X51.5/46.5	8.5	40	160		100
A455 434 L125K P098		125	95X70	75X50	11	40	160		100
A455 434 L150K P077		150	77X67	61.5/56X51.5/46.5	8.5	40	185		100



Bockrolle		mm	mm	mm	mm	mm	mm	Kg
A455 434 B080K P077		080	77X67	61.5/56X51.5/46.5	8.5		111	80
A455 434 B100K P077		100	77X67	61.5/56X51.5/46.5	8.5		135	100
A455 434 B125K P077		125	77X67	61.5/56X51.5/46.5	8.5		160	100
A455 434 B125K P095		125	95X70	75X50	11		160	100
A455 434 B150K P077		150	77X67	61.5/56X51.5/46.5	8.5		185	100



Lenkrolle mit Total-Feststeller		mm	mm	mm	mm	mm	mm	mm	Kg
A455 434 L080K P077F		080	77X67	61.5/56X51.5/46.5	8.5	37	111	132	80
A455 434 L100K P077F		100	77X67	61.5/56X51.5/46.5	8.5	37	135	132	100
A455 434 L125K P077F		125	77X67	61.5/56X51.5/46.5	8.5	40	160	132	100
A455 434 L125K P095F		125	95X70	75X50	11	40	160	132	100
A455 434 L150K P077F		150	77X67	61.5/56X51.5/46.5	8.5	40	185	132	100



# Schwere Apparaterollen Serie A454 434...

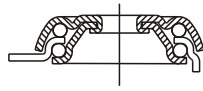

Radfelge: Polypropylen  
 Lauffläche: Thermoplast. Elastomer 95°Shore A  
 Lager: mittiges Kugellager  
 Fadenschutz: großer Kunststoff Fadenschutz  
 Traglast: 80kg bis 100kg  
 Raddurchmesser: 80mm bis 150mm  
 Temperaturbereich: -20°C bis +60°C



Rückenlochenkrolle					Kg
	mm	mm	mm	mm	
A454 434 L080K R11	080	11	37	111	80
A454 434 L100K R11	100	11	37	135	100
A454 434 L125K R11	125	11	40	160	100
A454 434 L150K R11	150	11	40	185	100



Rückenlochenkrolle mit Total-Feststeller						Kg
	mm	mm	mm	mm	mm	
A454 434 L080K R11F	080	11	37	111	132	80
A454 434 L100K R11F	100	11	37	135	132	100
A454 434 L125K R11F	125	11	40	160	132	100
A454 434 L150K R11F	150	11	40	185	132	100



Expander	Typ	Spannweite	Schraube	Material
ZUB SPH R19-21 5	Expander für Rundrohr	19-21.5mm	M10x90	Aluminium / Nylon
ZUB SPH R21 5-24	Expander für Rundrohr	21.5-24mm	M10x90	Aluminium / Nylon
ZUB SPH R24-27	Expander für Rundrohr	24-27mm	M10x90	Aluminium / Nylon
ZUB SPH R27-30	Expander für Rundrohr	27-30mm	M10x90	Aluminium / Nylon
ZUB SPH R31-35	Expander für Rundrohr	31-35mm	M10x90	Aluminium / Nylon



Expander	Typ	Bohrung	Schraube	Material
ZUB SPH V21 5-24	Expander für Quadratrohr	21.5-24mm	M10x90	Aluminium / Nylon
ZUB SPH V24-27	Expander für Quadratrohr	24-27mm	M10x90	Aluminium / Nylon
ZUB SPH V27-30	Expander für Quadratrohr	27-30mm	M10x90	Aluminium / Nylon
ZUB SPH V31-35	Expander für Quadratrohr	31-35mm	M10x90	Aluminium / Nylon
ZUB SPH V36-40	Expander für Quadratrohr	36-40mm	M10x90	Aluminium / Nylon

# Doppelrollen Serie A450 434...

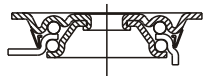

Radfelge: Polypropylen  
 Lauffläche: Thermoplast. Elastomer 95°Shore A  
 Lager: Gleitlager/ mittiges Kugellager  
 Fadenschutz: ohne/ kleiner Kunststoff Fadenschutz  
 Traglast: 70kg bis 100kg  
 Raddurchmesser: 50mm bis 75mm  
 Temperaturbereich: -20°C bis +60°C



Lenkrolle								
	mm	mm	mm	mm	mm	mm	mm	Kg
A450 434 L050G P060	050	60X60	48/38X48/38	6.3	25	72		70
A450 434 L050K P060		050	60X60	48/38X48/38	6.3	25	72	70
A450 434 L075G P060	075	77X67	61.5/56X51.5/46.5	8.5	32	100		100
A450 434 L075K P060		075	77X67	61.5/56X51.5/46.5	8.5	32	100	100



Lenkrolle mit Total-Feststeller									
	mm	mm	mm	mm	mm	mm	mm	mm	Kg
A450 434 L050G P060F	050	60X60	48/38X48/38	6.3	25	72	80		70
A450 434 L050K P060F		050	60X60	48/38X48/38	6.3	25	72	80	70
A450 434 L075G P077F	075	77X67	61.5/56X51.5/46.5	8.5	32	102	96		100
A450 434 L075K P077F		075	77X67	61.5/56X51.5/46.5	8.5	32	102	96	100



Einbaurad mit Achsmaterial						
	mm	mm	mm	mm	Ø	Kg
B150 155 050G	050	19	22	8	M6	50
B150 155 075G	075	25	30	8	M8	75







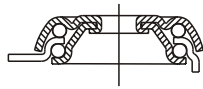

Einbaurad mit Achsmaterial							
	mm	mm	mm	mm	Ø	Kg	
B155 434 050x19 K 10		050	19	22	10	M6	50
B155 434 075x25 K 10		075	25	30	10	M8	75

# Doppelrollen Serie A450 434...











Radfelge: Polypropylen  
 Lauffläche: Thermoplast. Elastomer 95°Shore A  
 Lager: Gleitlager/ mittiges Kugellager  
 Fadenschutz: ohne/ kleiner Kunststoff Fadenschutz  
 Traglast: 70kg bis 100kg  
 Raddurchmesser: 50mm bis 75mm  
 Temperaturbereich: -20°C bis +60°C









Rückenlochlenkrolle					
	mm	mm	mm	mm	Kg
A450 434 L050G R11	050	11	25	70	70
A450 434 L050K R11		050	11	25	70
A450 434 L075G R11	075	11	32	100	100
A450 434 L075K R11		075	11	32	100











Rückenlochlenkrolle mit Total-Feststeller						
	mm	mm	mm	mm	mm	Kg
A450 434 L050G R11F	050	11	25	70	80	70
A450 434 L050K R11F		050	11	25	70	70
A450 434 L075G R11F	075	11	32	100	96	100
A450 434 L075K R11F		075	11	32	96	100



Einbaurad mit Achsmaterial						
	mm	mm	mm	mm	Ø	Kg
B150 434 050x19 G08A	050	19	22	8	M6	50
B150 155 075x25 G08A	075	25	30	8	M8	75



Einbaurad mit Achsmaterial							
	mm	mm	mm	mm	Ø	Kg	
B155 434 050x19 K06A		050	19	22	10	M6	50
B155 434 075x25 K08A		075	25	30	10	M8	75



## Einkaufswagenrollen





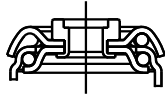

Unsere Rollen bewegen sich auch in Einkaufszentren und Supermärkten. Für einen besseren Komfort und schnelleren Einkauf im Supermarkt.

# Einkaufswagenrollen Serie A440 434...



Radfelge: Polypropylen  
 Lauffläche: Thermoplast. Elastomer 85°Shore A  
 Lager: mittiges Kugellager  
 Fadenschutz: großer Kunststoff Fadenschutz  
 Traglast: 75kg bis 100kg  
 Raddurchmesser: 75mm bis 125mm  
 Temperaturbereich: -20°C bis +60°C



Lenkrolle	 mm	 mm	 mm	 mm	 Kg
A440 434 L075 R10 3	075	10.3	30	100	75
A440 434 L100 R11	100	11	36	126	100
A440 434 L125 R13	125	13	38	155	100

## Befestigungsmöglichkeit:

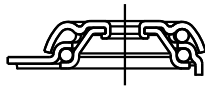

Rückenloch/ wie Apparate

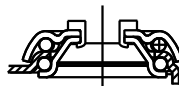

Rückenloch/ Niet oben

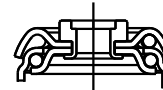



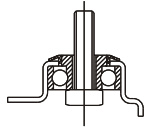

Rückenloch/ Innensechskant

## Einkaufswagenrollen Serie A441 434...



Radfelge: Polypropylen  
 Lauffläche: Thermoplast. Elastomer 85°Shore A  
 Lager: mittiges Kugellager  
 Fadenschutz: großer Kunststoff Fadenschutz  
 Traglast: 75kg bis 100kg  
 Raddurchmesser: 75mm bis 125mm  
 Temperaturbereich: -20°C bis +60°C



Lenkrolle	 mm	 mm	 mm	 mm	 Kg
A441 434 L125 R12	125	12	38	155	100



## Transportgeräterollen



Wir bieten eine große Auswahl an Gehäusen und Rädern für verschiedene Einsatzzwecke.

## Innovation

Die neue Innovation Serie steht in erster Linie für Wettbewerb! Einfach, stark, innovativ – der ultimative Preisbrecher.

	80mm	100mm	125mm
Vernietung	gebördelt	gebördelt	gebördelt
Nabe	42mm	42mm	52mm
Achse	8mm	8mm	8mm / 10mm
FST	Nein	Nein	Nein
Bauhöhe	105mm	125mm	155mm
Traglast	bis 150kg	bis 150kg	bis 200kg
Highlights	Edelstahl		



## Basics

Basics - Räder und Rollen, die den Alltag erleichtern. Unsere günstige Linie ohne qualitative Einschränkungen.

	80mm	100mm	125mm
Vernietung	Hohlriet	Hohlriet	Hohlriet
Nabe	42mm	42mm	52mm
Achse	8mm	8mm	8mm / 10mm
FST	Standard	Standard	Standard
Bauhöhe	105mm	125mm	155mm
Traglast	bis 150kg	bis 150kg	bis 200kg





## Flex.

Besondere Anforderungen erfordern besondere Maßnahmen. Seien Sie flexibler mit Flex, Ihrer Lösung für ein erfolgreiches Geschäft.

	80mm	100mm	125mm	160mm	200mm
Vernietung	Vollniet	Vollniet	Vollniet	Vollniet	Vollniet
Nabe	42mm	42mm	52mm	60mm	60mm
Achse	8mm	8mm	8mm/10mm	12mm	12mm
FST	Standard	Standard	Standard	einstellbar	einstellbar
Bauhöhe	100mm	125mm	155mm	190mm	235mm
Traglast	bis 150kg	bis 150kg	bis 200kg	bis 300kg	bis 300kg
Highlights	Richtungsfeststeller				



## Premium.

Mit Premium kommt Ihr Gut gut ins Rollen. Besonderes Augenmerk liegt hier auf Materialstärken und Stabilität. Lassen Sie sich überzeugen.

	80mm	100mm	125mm	160mm	200mm
Vernietung	Vollniet	Vollniet	Vollniet	Vollniet	Vollniet
Nabe	42mm	42mm	52mm	60mm	60mm
Achse	8mm	8mm	8mm/10mm	12mm	12mm
FST	Standard	Standard	Standard	Standard	Standard
Bauhöhe	105mm	128mm	155mm	195mm	235mm
Traglast	bis 180kg	bis 250kg	bis 300kg	bis 350kg	bis 400kg
Highlights	auch verfügbar mit Anschraubplatte 135 x 110 mm				









# Transportgeräterollen Basics Serie A505 434...









Radfelge: Polypropylen  
 Lauffläche: Polypropylen  
 Lager: Rollenlager  
 Fadenschutz: kleiner Metall-Fadenschutz  
 Traglast: 80kg bis 250kg  
 Raddurchmesser: 80mm bis 200mm  
 Temperaturbereich: -20°C bis +60°C











Lenkrolle							
	mm	mm	mm	mm	mm	mm	Kg
A505 434 L080R P105	080	105X80	80/77x60	9	40	105	80
A505 434 L100G P105 A505 434 L100R P105	100	105X80	80/77x60	9	40	125	100
A505 434 L125R P105 A505 434 L125K P105	125	105X80	80/77x60	9	40	155	150
A505 434 L160R P135	160	135X110	105x84/76	11	55	195	250
A505 434 L200R P135	200	135X110	105x84/76	11	55	235	250



Bockrolle						
	mm	mm	mm	mm	mm	Kg
A505 434 B080R P105	080	105X80	80/77x60	9	105	80
A505 434 B100G P105 A505 434 B100R P105	100	105X80	80/77x60	9	125	100
A505 434 B125R P105 A505 434 B125K P105	125	105X80	80/77x60	9	155	150
A505 434 B160R P135	160	135X110	105x84/76	11	195	250
A505 434 B200R P135	200	135X110	105x84/76	11	235	250



Lenkrolle mit Total-Feststeller								
	mm	mm	mm	mm	mm	mm	mm	Kg
A505 434 L080R P105F	080	105X80	80/77x60	9	40	105	127	80
A505 434 L100G P105F A505 434 L100R P105F	100	105X80	80/77x60	9	40	125	127	100
A505 434 L125R P105F A505 434 L125K P105F	125	105X80	80/77x60	9	45	155	127	150
A505 434 L160R P105F	160	135X110	105x84/76	11	55	195	165	250
A505 434 L200R P105F	200	135X110	105x84/76	11	55	235	165	250

# Transportgeräterollen Basics Serie A505 434...

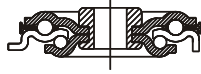

Radfelge: Polypropylen  
 Laufläche: Polypropylen  
 Lager: Rollenlager  
 Fadenschutz: kleiner Metall-Fadenschutz  
 Traglast: 80kg bis 250kg  
 Raddurchmesser: 80mm bis 200mm  
 Temperaturbereich: -20°C bis +60°C



Rückenlochenkrolle						
	mm	mm	mm	mm	mm	Kg
A505 434 L080R RL13	080	13	40	104	80	
A505 434 L100G RL13 A505 434 L100R RL13	100	13	40	124	100	
A505 434 L125R RL13 A505 434 L125K RL13	125	13	40	154	150	
A505 434 L160R RL13	160	13	55	189	200	
A505 434 L200R RL13	200	13	55	228	200	



Rückenlochenkrolle mit Total-Feststeller							
	mm	mm	mm	mm	mm	mm	Kg
A505 434 L080R RL13F	080	13	40	104	127	80	
A505 434 L100G RL13F A505 434 L100R RL13F	100	13	40	124	127	100	
A505 434 L125R RL13F A505 434 L125K RL13F	125	13	45	154	127	150	
A505 434 L160R RL13F	160	13	55	189	165	200	
A505 434 L200R RL13F	200	13	55	228	165	200	



Einbaurad mit Achsmaterial						
	mm	mm	mm	mm	Ø	Kg
B630 434 080 R 12	080	34	40	12	M8	80
B630 434 100 G 12 B630 434 100 R 12	100	36	40	12	M8	100
B630 434 125 R 12 B630 434 125 K 15	125	38	50	12	M8	150 150
B630 434 160 R 20	160	50	59	20	M12	250
B630 434 200 R 20	200	50	59	20	M12	250

# Rollbehälterrollen Basics Serie A505 434...



Radfelge: Polypropylen (P)/ Polypropylen mit Stahlrohr (Q)  
 Lauffläche: Polypropylen (P)  
 Lager: Rollenlager  
 Fadenschutz: kleiner Metall-Fadenschutz  
 Traglast: 120kg bis 150kg  
 Raddurchmesser: 108mm  
 Temperaturbereich: -20°C bis +60°C



Lenkrolle								
	mm	mm	mm	mm	mm	mm	mm	Kg
A505 434 L108R P1085	108	105X80	80/77x60	9	40	132		150



Bockrolle							
	mm	mm	mm	mm	mm	mm	Kg
A505 434 B108R P105	108	105X80	80/77x60	9		132	150



Bockrolle erst rkt							
	mm	mm	mm	mm	mm	mm	Kg
A505 434 B108R P105	108	105X80	80/77x60	9		132	150







Lenkrolle mit Total-Feststeller									
	mm	mm	mm	mm	mm	mm	mm	mm	Kg
A505 434 L108R P105	108	105X80	80/77x60	9	45	132	127		150

# Rollbehälterrollen Basics Serie A505 434...









Radfelge: Polypropylen (P)/ Polypropylen mit Stahlrohr (Q)  
 Lauffläche: Polypropylen (P)  
 Lager: Rollenlager  
 Fadenschutz: kleiner Metall-Fadenschutz  
 Traglast: 120kg bis 150kg  
 Raddurchmesser: 108mm  
 Temperaturbereich: -20°C bis +60°C









Rückenlochlenkrolle	 mm	 mm	 mm	 mm	 Kg
A505 434 L108R RL13	108	13	40	131	120



Rückenlochlenkrolle mit Total-Feststeller	 mm	 mm	 mm	 mm	 mm	 Kg
A505 434 L108R RL13F	108	13	45	131	127	120



Einbaurad mit Achsmaterial	 mm	 mm	 mm	 mm	 Ø	 Kg
B630 434 108R RL12	108	36	40	12	M8	150

# Transportgeräterollen Premium Serie A505 434P...

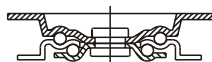

Radfelge: Polyamid (N)/ Polyamid mit Stahlrohr (H)  
 Lauffläche: Polyamid (N)  
 Lager: Rollenlager  
 Fadenschutz: kleiner Metall-Fadenschutz  
 Traglast: 130kg bis 300kg  
 Raddurchmesser: 80mm bis 200mm  
 Temperaturbereich: -40°C bis +80°C



Lenkrolle								
	mm	mm	mm	mm	mm	mm	mm	Kg
A505 434P 080R P105		080	105X80	80/77x60	9	40	105	130
A505 434P 100G P105 A505 434P 100R P105		100	105X80	80/77x60	9	40	128	150
A505 434P 125R P105 A505 434P 125K P105		125	105X80	80/77x60	9	40	155	200
A505 434P 160R P135		160	135X110	105x84/76	11	55	195	300
A505 434P 200R P135		200	135X110	105x84/76	11	55	235	300



Bockrolle							
	mm	mm	mm	mm	mm	mm	Kg
A505 434P B080R P105		080	105X80	80/77x60	9	105	130
A505 434P B100G P105 A505 434P B100R P105		100	105X80	80/77x60	9	128	150
A505 434P B125R P105 A505 434P B125K P105		125	105X80	80/77x60	9	155	200
A505 434P B160R P135		160	135X110	105x84/76	11	195	300
A505 434P B160R P135		200	135X110	105x84/76	11	235	300















Lenkrolle mit Total-Feststeller									
	mm	mm	mm	mm	mm	mm	mm	Kg	
A505 434P L080R P105		080	105X80	80/77x60	9	40	105	127	130
A505 434P L100G P105 A505 434P L100R P105		100	105X80	80/77x60	9	40	128	127	150
A505 434P L125R P105 A505 434P L125K P105		125	105X80	80/77x60	9	45	155	127	200
A505 434P L160R P105		160	135X110	105x84/76	11	55	195	165	300
A505 434P L200R P105		200	135X110	105x84/76	11	55	235	165	300

# Transportgeräterollen Premium Serie A505 434P...















Radfelge: Polyamid (N)/ Polyamid mit Stahlrohr (H)  
 Lauffläche: Polyamid (N)  
 Lager: Rollenlager  
 Fadenschutz: kleiner Metall-Fadenschutz  
 Traglast: 130kg bis 300kg  
 Raddurchmesser: 80mm bis 200mm  
 Temperaturbereich: -40°C bis +80°C



Rückenlochenkrolle					
	mm	mm	mm	mm	Kg
A505 434P L080R RL13	 080	13	40	104	130
A505 434P L100G RL13	 100	13	40	127	150
A505 434P L100R RL13	 100	13	40	127	150
A505 434P L125R RL13	 125	13	40	154	150
A505 434P L125K RL13	 125	13	40	154	150
A505 434P L160R RL13	 160	13	55	189	200
A505 434P L200R RL13	 200	13	55	228	200



Rückenlochenkrolle mit Total-Feststeller						
	mm	mm	mm	mm	mm	Kg
A505 434P L080R RL13F	 080	13	40	104	127	130
A505 434P L100G RL13F	 100	13	40	127	127	150
A505 434P L100R RL13F	 100	13	40	127	127	150
A505 434P L125R RL13F	 125	13	45	154	127	150
A505 434P L125K RL13F	 125	13	45	154	127	150
A505 434P L160R RL13F	 160	13	55	189	165	200
A505 434P L200R RL13F	 200	13	55	228	165	200

# Rollbehälterrollen Premium Serie A505 434...

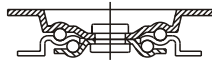

Radfelge: Polyamid (N)/ Polyamid mit Stahlbuchse (H)  
 Lauffläche: Polyamid (N)  
 Lager: Rollenlager  
 Fadenschutz: kleiner Metall-Fadenschutz  
 Traglast: 150kg bis 200kg  
 Raddurchmesser: 108mm  
 Temperaturbereich: -40°C bis +80°C



Lenkrolle								
	mm	mm	mm	mm	mm	mm	mm	Kg
A505 434 L108R P105		108	105X80	80/77x60	9	40	132	200
A505 434 L108K P105		108	105X80	80/77x60	9	40	132	200



Bockrolle							
	mm	mm	mm	mm	mm	mm	Kg
A505 434 B108R P105		108	105X80	80/77x60	9	132	200
A505 434 B108K P105		108	105X80	80/77x60	9	132	200



Bockrolle (verstärkt)							
	mm	mm	mm	mm	mm	mm	Kg
A505 434 V B108R P105		108	105X80	80/77x60	9	132	200
A505 434 V B108K P105		108	105X80	80/77x60	9	132	200



Bockrolle								
	mm	mm	mm	mm	mm	mm	mm	Kg
A505 434P BL108 100		108	100X90	78x60	9	36	132	200



Lenkrolle mit Total-Feststeller									
	mm	mm	mm	mm	mm	mm	mm	mm	Kg
A505 434 L108R P105F		108	105X80	80/77x60	9	45	132	127	200
A505 434 L108K P105F		108	105X80	80/77x60	9	45	132	127	200



# Rollbehälterrollen Premium Serie A505 434...



Radfelge: Polyamid (N)/ Polyamid mit Stahlbuchse (H)  
 Lauffläche: Polyamid (N)  
 Lager: Rollenlager  
 Fadenschutz: kleiner Metall-Fadenschutz  
 Traglast: 150kg bis 200kg  
 Raddurchmesser: 108mm  
 Temperaturbereich: -40°C bis +80°C



Rückenlochlenkrolle						
	mm	mm	mm	mm	mm	Kg
A505 434P L108R RL13		108	13	40	131	150
A505 434P L108K RL13						



Rückenlochlenkrolle mit Total-Feststeller						
	mm	mm	mm	mm	mm	Kg
A505 434P L108R RL13F		108	13	45	131	150
A505 434P L108K RL13F						



Einbaurad mit Achsmaterial						
	mm	mm	mm	mm	Ø	Kg
B630 434 108R RL12		108	36	40	12	M8
B630 434 108K RL12						



# Transportgeräterollen Premium Serie A505 434P...

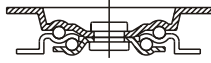

Radfelge: Polypropylen/ Polypropylen mit Stahlbuchse (Q)  
 Lauffläche: Polypropylen  
 Lager: Rollenlager  
 Fadenschutz: kleiner Metall-Fadenschutz  
 Traglast: 200kg  
 Raddurchmesser: 125mm  
 Temperaturbereich: -20°C bis +60°C



Lenkrolle								
	mm	mm	mm	mm	mm	mm	mm	Kg
A505 434P L125R P135	125	135X110	105x84/76	11	50	125	155	200



Bockrolle							
	mm	mm	mm	mm	mm	mm	Kg
A505 434P B125R P135	125	135X110	105x84/76	11	50	155	200



Lenkrolle mit Total-Feststeller									
	mm	mm	mm	mm	mm	mm	mm	mm	Kg
A505 454P L125R P135F	125	135X110	105x84/76	11	55	125	155	154	200

# Transportgeräterollen Premium Serie A495 434...

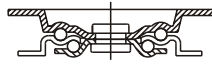

Radfelge: Polypropylen mit TPR Ring  
 Lauffläche: Polypropylen  
 Lager: Rollenlager  
 Fadenschutz: kleiner Metall-Fadenschutz  
 Traglast: 160kg bis 200kg  
 Raddurchmesser: 100mm bis 125mm  
 Temperaturbereich: -20°C bis +80°C



Lenkrolle								
	mm	mm	mm	mm	mm	mm	mm	Kg
A495 434 TL100R P105	100	105X80	80/77x60	9	40	128		160
A945 434 TL125R P105	125	105X80	80/77x60	9	40	155		200



Bockrolle							
	mm	mm	mm	mm	mm	mm	Kg
A495 434 TL100R P105	100	105X80	80/77x60	9		128	160
A495 434 TL125R P105	125	105X80	80/77x60	9		155	200



Lenkrolle mit Total-Feststeller								
	mm	mm	mm	mm	mm	mm	mm	Kg
A495 434 TL100R P105F	100	105X80	80/77x60	9	40	128	127	160
A495 434 TL125R P105F	125	105X80	80/77x60	9	45	155	127	200



Einbaurad mit Achsmaterial						
	mm	mm	mm	mm	Ø	Kg
B424 434 TL100Rx36 RL12	100	36	40	12	M8	160
B424 434 L125Rx36 RL12	125	36	50	15	M10	200



# Transportgeräterollen Premium Serie A495 434...

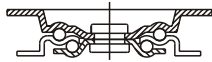

Radfelge: Polyamid mit Elastik Ring  
 Lauffläche: Polyamid  
 Lager: Rollenlager  
 Fadenschutz: kleiner Kunststoff-Fadenschutz  
 Traglast: 160kg bis 200kg  
 Raddurchmesser: 100mm bis 125mm  
 Temperaturbereich: -20°C bis +80°C



Lenkrolle								
	mm	mm	mm	mm	mm	mm	mm	Kg
A495 434 L100R P105	100	105X80	80/77x60	9	40	128		160
A945 434 L125R P105	125	105X80	80/77x60	9	40	155		200



Bockrolle						
	mm	mm	mm	mm	mm	Kg
A495 434 B100R P105	100	105X80	80/77x60	9	128	160
A945 434 B125R P105	125	105X80	80/77x60	9	155	200



Lenkrolle mit Total-Feststeller								
	mm	mm	mm	mm	mm	mm	mm	Kg
A495 434 L100R P105F	100	105X80	80/77x60	9	40	128	127	160
A495 434 L125R P105F	125	105X80	80/77x60	9	45	155	127	200



Einbaurad mit Achsmaterial						
	mm	mm	mm	mm	Ø	Kg
B424 434 100Rx36 RL12	100	36	40	12	M8	160
B424 434 125Rx36 RL15	125	36	50	15	M10	200

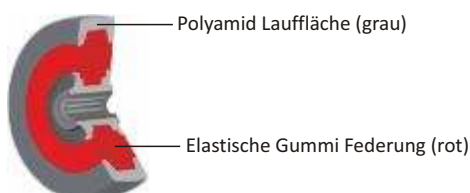

# Transportgeräterollen Premium Serie A505 434...

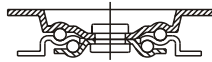

Radfelge: Polyamid  
 Lauffläche: Thermopl. Polyurethan 95° Shore A  
 Lager: Rollenlager/ mittiges Kugellager  
 Fadenschutz: kleiner Metall-/ Kunststoff-Fadenschutz  
 Traglast: 130kg bis 350kg  
 Raddurchmesser: 80mm bis 200mm  
 Temperaturbereich: -40°C bis +80°C



Lenkrolle							
	mm	mm	mm	mm	mm	mm	Kg
A508 434 L080R P105 A508 434 L080K P105	080	105x80	80/77x60	9	40	105	130
A508 434 L100R P105 A508 434 L100K P105	100	105x80	80/77x60	9	40	125 128	150
A508 434 L125R P105 A508 434 L125K P105	125	105x80	80/77x60	9	40	155	200



Bockrolle							
	mm	mm	mm	mm	mm	mm	Kg
A508 434 B080R P105 A508 434 B080K P105	080	105x80	80/77x60	9		105	130
A508 434 B100R P105 A508 434 B100K P105	100	105x80	80/77x60	9		125 128	150
A508 434 B125R P105 A508 434 B125K P105	125	105x80	80/77x60	9		155	200



Lenkrolle mit Total-Feststeller								
	mm	mm	mm	mm	mm	mm	mm	Kg
A508 434 L080R P105F A508 434 L080K P105F	080	105x80	80/77x60	9	40	105	127	130
A508 434 L100R P105F A508 434 L100K P105F	100	105x80	80/77x60	9	40	125 128	127	150
A508 434 L125R P105F A508 434 L125K P105F	125	105x80	80/77x60	9	45	155	127	200



Einbaurad mit Achsmaterial						
	mm	mm	mm	mm	Ø	Kg
B631 434 080X32R12M8 B631 434 080X32K15M8	080	32	40	12 15	M8	130
B631 434 100X32R12M8 B631 434 100X32K12M8	100	32	40	12 15	M8	150
B631 434 125X32R15M8 B631 434 125X32K15M8	125	32	50	15	M10	200



# Transportgeräterollen Premium Serie A508 434...



Radfelge: Polyamid  
 Lauffläche: Thermopl. Polyurethan 95° Shore A  
 Lager: Rollenlager/ Doppelkugellager  
 Fadenschutz: kleiner Metall-/ Kunststoff-Fadenschutz  
 Traglast: 130kg bis 350kg  
 Raddurchmesser: 80mm bis 200mm  
 Temperaturbereich: -40°C bis +80°C

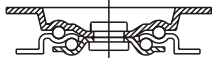

Lenkrolle								
	mm	mm	mm	mm	mm	mm	Kg	
A508 434 L160R P135 A508 434 L160K P135		160	135x110	105x84/76	11	55	195	300
A508 434 L200R P135 A508 434 L200K P135		200	135x110	105x84/76	11	55	235	350



Bockrolle							
	mm	mm	mm	mm	mm	Kg	
A508 434 B160R P135 A508 434 B160K P135		160	135x110	105x84/76	11	195	300
A508 434 B200R P135 A508 434 B200K P135		200	135x110	105x84/76	11	235	350



Lenkrolle mit Total-Feststeller									
	mm	mm	mm	mm	mm	mm	mm	Kg	
A508 434 L160R P135F A508 434 L160K P135F		160	135x110	105x84/76	11	55	195	165	300
A508 434 L200R P135F A508 434 L200K P135F		200	135x110	105x84/76	11	55	235	165	350



Einbaurad mit Achsmaterial							
	mm	mm	mm	mm	Ø	Kg	
B631 434R 160R RL20 B631 434R 160K RL20		160	40	59	20	M12	300
B631 434R 200R RL20 B631 434R 200K RL20		200	50	59	20	M12	350

# Transportgeräterollen Basics Serie A511 434...

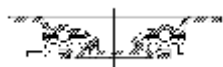

Radfelge: Polyamid  
 Lauffläche: Elastik blau 75° Shore A  
 Lager: Rollenlager/ Doppel-/ mittiges Kugellager  
 Fadenschutz: ohne/ kleiner Kunststoff-Fadenschutz  
 Traglast: 130kg bis 350kg  
 Raddurchmesser: 80mm bis 200mm  
 Temperaturbereich: -20°C bis +80°C



Lenkrolle								
	mm	mm	mm	mm	mm	mm	mm	Kg
A511 434 L080R P105 A511 434 L080K P105		080	105X80	80/77x60	9	40	105	130
A511 434 L100R P105 A511 434 L100K P105		100	105X80	80/77x60	9	40	125	160
A511 434 L125R P105 A511 434 L125K P105		125	105X80	80/77x60	9	40	155	200
A511 434 L160R P135 A511 434 L160K P135		160	135X110	105X84/76	11	55	195	300
A511 434 L200R P135 A511 434 L200K P135		200	135X110	105X84/76	11	55	235	350



Bockrolle							
	mm	mm	mm	mm	mm	mm	Kg
A511 434 B080R P105 A511 434 B080K P105		080	105X80	80/77x60	9	105	130
A511 434 B100R P105 A511 434 B100K P105		100	105X80	80/77x60	9	125	160
A511 434 B125R P105 A511 434 B125K P105		125	105X80	80/77x60	9	155	200
A511 434 B160R P135 A511 434 B160K P135		160	135X110	105X84/76	11	195	300
A511 434 B200R P135 A511 434 B200K P135		200	135X110	105X84/76	11	235	350



Lenkrolle mit Total-Feststeller								
	mm	mm	mm	mm	mm	mm	mm	Kg
A511 434 L080R P105F A511 434 L080K P105F		080	105X80	80/77x60	9	40	105	130
A511 434 L100R P105F A511 434 L100K P105F		100	105X80	80/77x60	9	40	127	160
A511 434 L125R P135F A511 434 L125K P135F		125	105X80	80/77x60	9	45	127	200
A511 434 L160R P135F A511 434 L160K P135F		160	135X110	105X84/76	11	55	165	300
A511 434 L200R P135F A511 434 L200K P135F		200	135X110	105X84/76	11	55	165	350

# Transportgeräterollen Basics Serie A511 434...

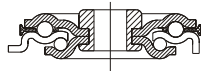

Radfelge: Polyamid  
 Lauffläche: Elastik blau 75° Shore A  
 Lager: Rollenlager/ Doppel-/ mittiges Kugellager  
 Fadenschutz: ohne/ kleiner Kunststoff-Fadenschutz  
 Traglast: 130kg bis 350kg  
 Raddurchmesser: 80mm bis 200mm  
 Temperaturbereich: -20°C bis +80°C



Rückenlochenkrolle					
	mm	mm	mm	mm	Kg
A511 434 L080R RL13 A511 434 L080K RL13	80	13	40	104	130
A511 434 L100R RL13 A511 434 L100K RL13	100	13	40	124	150
A511 434 L125R RL13 A511 434 L125K RL13	125	13	40	154	150
A511 434 L160R RL13 A511 434 L160K RL13	160	13	55	189	200
A511 434 L200R RL13 A511 434 L200K RL13	200	13	55	228	250



Rückenlochenkrolle mit Total-Feststeller						
	mm	mm	mm	mm	mm	Kg
A511 434 L080R RL13F A511 434 L080K RL13F	80	13	40	104	127	130
A511 434 L100R RL13F A511 434 L100K RL13F	100	13	40	124	127	150
A511 434 L125R RL13F A511 434 L125K RL13F	125	13	45	154	127	150
A511 434 L160R RL13F A511 434 L160K RL13F	160	13	55	189	165	200
A511 434 L200R RL13F A511 434 L200K RL13F	200	13	55	228	165	250



(160-200mm)

Einbauroad mit Achsmaterial						
	mm	mm	mm	mm	Ø	Kg
B422 434 080R RL12 B422 434 080K RL12	80	35	40	12	M8	130
B422 434 100R RL12 B422 434 100K RL12	100	35	40	12	M8	160
B422 434 125R RL15 B422 434 125K RL15	125	38	50	15	M10	200
B422 434 160R RL20 B422 434 160K RL20	160	46	59	20	M12	300
B422 434 200R RL20 B422 434 200K RL20	200	46	59	20	M12	350



# Transportgeräterollen Premium Serie A511 434...

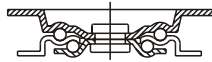

Radfelge: Polyamid  
 Lauffläche: Elastik grau 65° Shore A  
 Lager: Rollenlager/ mittiges Kugellager  
 Fadenschutz: ohne/ kleiner Kunststoff-Fadenschutz  
 Traglast: 150kg bis 200kg  
 Raddurchmesser: 80mm bis 125mm  
 Temperaturbereich: -20°C bis +80°C



Lenkrolle								
	mm	mm	mm	mm	mm	mm	mm	Kg
A511 434 L100GR P105 A511 434 L100KR P105		100	105X80	80/77x60	9	40	128	160
A511 434 L125GR P105 A511 434 L125KR P105		125	105X80	80/77x60	9	40	155	200



Bockrolle								
	mm	mm	mm	mm	mm	mm	mm	Kg
A511 434 B100GR P105 A511 434 B100KR P105		100	105X80	80/77x60	9		128	160
A511 434 B125GR P105 A511 434 B125KR P105		125	105X80	80/77x60	9		155	200







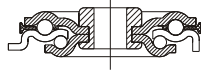







Lenkrolle mit Total-Feststeller									
	mm	mm	mm	mm	mm	mm	mm	mm	Kg
A511 434 L100GR P105F A511 434 L100KR P105F		100	105X80	80/77x60	9	40	128	127	160
A511 434 B125GR P105F A511 434 B125KR P105F		125	105X80	80/77x60	9	45	155	127	200

# Transportgeräterollen Premium Serie A511 434...



















Radfelge: Polyamid  
 Lauffläche: Elastik grau 65° Shore A  
 Lager: Rollenlager/ mittiges Kugellager  
 Fadenschutz: ohne/ kleiner Kunststoff-Fadenschutz  
 Traglast: 150kg bis 200kg  
 Raddurchmesser: 80mm bis 125mm  
 Temperaturbereich: -20°C bis +80°C

















Rückenlochenkrolle					
	mm	mm	mm	mm	Kg
A511 434 L100GR RL13 A511 434 L100KR RL13	 100	 13	 40	 127	150
A511 434 L125GR RL13 A511 434 L125KR RL13	 125	 13	 40	 154	150



Rückenlochenkrolle mit Total-Feststeller						
	mm	mm	mm	mm	mm	Kg
A511 434 L100GR RL13F A511 434 L100KR RL13F	 100	 13	 40	 127	 127	150
A511 434 L125GR RL13F A511 434 L125KR RL13F	 125	 13	 45	 154	 127	150



Einbaurad mit Achsmaterial						
	mm	mm	mm	mm	Ø	Kg
B422 434 100GR RL12 B422 434 100GK RL12	 100	 35	 40	 12	M8	160
B422 434 125GR RL15 B422 434 125GK RL15	 125	 38	 50	 15	M10	200

# Transportgeräterollen Basics Serie A300 434...



Radfelge: Polypropylen  
 Lauffläche: Thermopl. Elastomer 65° Shore A  
 Lager: mittiges Kugellager  
 Fadenschutz: kleiner Kunststoff-Fadenschutz  
 Traglast: 100kg bis 250kg  
 Raddurchmesser: 100mm bis 200mm  
 Temperaturbereich: -20°C bis +60°C



Lenkrolle								
	mm	mm	mm	mm	mm	mm	mm	Kg
A300 434 L100K P105	100	105X80	80/77x60	9	40	125		135
A300 434 L125K P105	125	105X80	80/77x60	9	40	155		165



Bockrolle							
	mm	mm	mm	mm	mm	mm	Kg
A300 434 B100K P105	100	105X80	80/77x60	9		125	135
A300 434 B125K P105	125	105X80	80/77x60	9		155	165







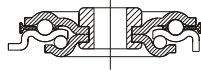

Lenkrolle mit Total-Feststeller								
	mm	mm	mm	mm	mm	mm	mm	Kg
A300 434 L100K P105F	100	105X80	80/77x60	9	40	125	127	135
A300 434 L125K P105F	125	105X80	80/77x60	9	45	155	127	165

# Transportgeräterollen Basics Serie A300 434...











Radfelge: Polypropylen  
 Lauffläche: Thermopl. Elastomer 65° Shore A  
 Lager: mittiges Kugellager  
 Fadenschutz: kleiner Kunststoff-Fadenschutz  
 Traglast: 100kg bis 250kg  
 Raddurchmesser: 100mm bis 200mm  
 Temperaturbereich: -20°C bis +60°C



Lenkrollenkrolle					
	mm	mm	mm	mm	Kg
A300 434 L100K RL13	 100	13	40	124	100
A300 434 L100K RL13	 125	13	40	154	135



Rückenlochenkrolle mit Total-Feststeller						
	mm	mm	mm	mm	mm	Kg
A300 434 L100K RL13F	 100	13	40	124	127	100
A300 434 L125K RL13F	 125	13	45	154	127	135

# Transportgeräterollen Premium Serie A300 434...

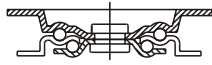

Radfelge: Polypropylen  
 Lauffläche: Thermopl. Elastomer 65° Shore A  
 Lager: mittiges Kugellager  
 Fadenschutz: kleiner Kunststoff-Fadenschutz  
 Traglast: 100kg bis 250kg  
 Raddurchmesser: 100mm bis 200mm  
 Temperaturbereich: -20°C bis +60°C



Lenkrolle								
	mm	mm	mm	mm	mm	mm	mm	Kg
A300 434 L160K P135	160	135x110	105x84/76	11	55	195		200
A300 434 L200K P135	200	135x110	105x84/76	11	55	235		250



Bockrolle							
	mm	mm	mm	mm		mm	Kg
A300 434 B160K P135	160	135x110	105x84/76	11		195	200
A300 434 L200K P135	200	135x110	105x84/76	11		235	250



Lenkrolle mit Total-Feststeller								
	mm	mm	mm	mm	mm	mm	mm	Kg
A300 434 L160K P135F	160	135x110	105x84/76	11	55	195	165	200
A300 434 L200K P135F	200	135x110	105x84/76	11	55	235	165	250



Einbaurad mit Achsenmaterial						
	mm	mm	mm	mm	Ø	Kg
B205 434 160K RL20	160	40	59	20	M12	200
B205 434 200K RL20	200	40	59	20	M12	250

# Transportgeräterollen Basics Serie B508 434...



Radfelge: Polypropylen  
 Lauffläche: Thermopl. Elastomer 85° Shore A  
 Lager: Rollenlager/ mittiges Kugellager  
 Fadenschutz: kleiner Metall-/ Kunststoff-Fadenschutz  
 Traglast: 80kg bis 200kg  
 Raddurchmesser: 80mm bis 200mm  
 Temperaturbereich: -20°C bis +60°C



Lenkrolle								
	mm	mm	mm	mm	mm	mm	mm	Kg
B508 434 L080R P105 B508 434 L080K P105		080	105X80	80/77x60	9	40	105	80
B508 434 L100R P105 B508 434 L100K P105		100	105X80	80/77x60	9	40	125	100
B508 434 L125R P105 B508 434 L125K P105		125	105X80	80/77x60	9	40	155	135



Bockrolle							
	mm	mm	mm	mm	mm	mm	Kg
B508 434 B080R P105 B508 434 B080K P105		080	105X80	80/77x60	9	105	80
B508 434 B100R P105 B508 434 B100K P105		100	105X80	80/77x60	9	125	100
B508 434 B125R P105 B508 434 B125K P105		125	105X80	80/77x60	9	155	135



Lenkrolle mit Total-Feststeller									
	mm	mm	mm	mm	mm	mm	mm	Kg	
B508 434 L080R P105F B508 434 L080K P105F		080	105X80	80/77x60	9	40	105	127	80
B508 434 L100R P105F B508 434 L100K P105F		100	105X80	80/77x60	9	40	125	127	100
B508 434 B125R P105F B508 434 B125K P105F		125	105X80	80/77x60	9	45	155	127	135



Einbauroad mit Achsmaterial							
	mm	mm	mm	mm	Ø	Kg	
B631 434 080AR RL12 B631 434 080AK RL15		080	32	40	12 15	M8	80
B631 434 100AR RL12 B631 434 100AK RL15		100	32	40	12 15	M8	100
B631 434 125AR RL15 B631 434 125AK RL15		125	32	50	15	M10	135



# Transportgeräterollen Premium Serie B508 434...

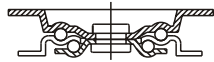

Radfelge: Polypropylen  
 Lauffläche: Thermopl. Elastomer 85° Shore A  
 Lager: Rollenlager/ mittiges Kugellager  
 Fadenschutz: kleiner Metall-/ Kunststoff-Fadenschutz  
 Traglast: 80kg bis 200kg  
 Raddurchmesser: 80mm bis 200mm  
 Temperaturbereich: -20°C bis +60°C



Lenkrolle								
	mm	mm	mm	mm	mm	mm	mm	Kg
A510 434 L160R P135 A510 434 L160K P135		160	135x110	105x84/76	11	55	195	200
A510 434 L200R P135 A510 434 L200K P135		200	135x110	105x84/76	11	55	235	200



Bockrolle							
	mm	mm	mm	mm	mm	mm	Kg
A510 434 B160R P135 A510 434 B160K P135		160	135x110	105x84/76	11	195	200
A510 434 B200R P135 A510 434 B200K P135		200	135x110	105x84/76	11	235	200



Lenkrolle mit Total-Feststeller									
	mm	mm	mm	mm	mm	mm	mm	mm	Kg
A510 434 L160R P135F A510 434 L160K P135F		160	135x110	105x84/76	11	55	195	165	200
A510 434 L200R P135F A510 434 L200K P135F		200	135x110	105x84/76	11	55	235	165	200



Einbaurod mit Achsmaterial							
	mm	mm	mm	mm	mm	Ø	Kg
B631 434 160AR RL20 B631 434 160AK RL20		160	40	59	20	M12	200
B631 434 200AR RL20 B631 434 200AK RL20		200	50	59	20	M12	200

# Transportgeräterollen Basics Serie A510 434...



Radfelge: Stahlblech  
 Lauffläche: Vollgummi schwarz 85° Shore A  
 Lager: Rollenlager  
 Fadenschutz: ohne  
 Traglast: 70kg bis 205kg  
 Raddurchmesser: 80mm bis 200mm  
 Temperaturbereich: -20°C bis +60°C



Lenkrolle								
	mm	mm	mm	mm	mm	mm	mm	Kg
A510 434 L080R P105	080	105X80	80/77x60	9	40	105		70
A510 434 L100R P105	100	105X80	80/77x60	9	40	125		75
A510 434 L125R P105	125	105X80	80/77x60	9	40	155		100
A510 434 L160R P135	160	135X110	105X84/76	11	55	195		135
A510 434 L200R P135	200	135X110	105X84/76	11	55	235		205



Bockrolle							
	mm	mm	mm	mm	mm	mm	Kg
A510 434 L080R P105	080	105X80	80/77x60	9		105	70
A510 434 L100R P105	100	105X80	80/77x60	9		125	75
A510 434 L125R P105	125	105X80	80/77x60	9		155	100
A510 434 L160R P135	160	135X110	105x84/76	11		195	135
A510 434 L200R P135	200	135X110	105x84/76	11		235	205



Lenkrolle mit Total-Feststellersteller								
	mm	mm	mm	mm	mm	mm	mm	Kg
A510 434 L080R P105F	080	105X80	80/77x60	9	40	105	127	70
A510 434 L100R P105F	100	105X80	80/77x60	9	40	125	127	75
A510 434 L125R P105F	125	105X80	80/77x60	9	45	155	127	100
A510 434 L160R P135F	160	135X110	105x84/76	11	55	195	165	135
A510 434 L200R P135F	200	135X110	105x84/76	11	55	235	165	205





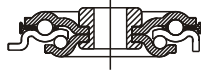

# Transportgeräterollen Basics Serie A510 434...









Radfelge: Stahlblech  
 Lauffläche: Vollgummi schwarz 85° Shore A  
 Lager: Rollenlager  
 Fadenschutz: ohne  
 Traglast: 70kg bis 205kg  
 Raddurchmesser: 80mm bis 200mm  
 Temperaturbereich: -20°C bis +60°C









Rückenlochlenkrolle					
	mm	mm	mm	mm	Kg
A510 434 L080R RL13	080	13	40	104	70
A510 434 L100R RL13	100	13	40	124	75
A510 434 L125R RL13	125	13	40	154	100
A510 434 L160R RL13	160	13	55	189	135
A510 434 L200R RL13	200	13	55	228	205



Rückenlochlenkrolle mit Total-Feststeller						
	mm	mm	mm	mm	mm	Kg
A510 434 L080R RL13	080	13	40	104	127	70
A510 434 L100R RL13	100	13	40	124	127	75
A510 434 L125R RL13	125	13	45	154	127	100
A510 434 L160R RL13	160	13	55	189	165	135
A510 434 L200R RL13	200	13	55	228	165	205



Einbaurad mit Achsmaterial						
	mm	mm	mm	mm	Ø	Kg
B415 434 080R RL12	080	27	40	12	M 8	70
B415 434 100R RL12	100	27	40	12	M 8	75
B415 434 125R RL12	125	38	50	12	M8 M10	100
B415 434 160R RL20	160	40	59	20	M12	135
B415 434 200R RL20	200	50	59	20	M12	205

# Transportgeräterollen Basics Serie A510 434G...

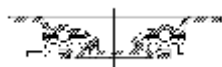

Radfelge: Stahlblech  
 Lauffläche: Vollgummi grau 85° Shore A  
 Lager: Rollenlager  
 Fadenschutz: ohne  
 Traglast: 70kg bis 205kg  
 Raddurchmesser: 80mm bis 200mm  
 Temperaturbereich: -20°C bis +60°C



Lenkrolle								
	mm	mm	mm	mm	mm	mm	mm	Kg
A510 434G L080R P105	080	105X80	80/77x60	9	40	105		70
A510 434G L100R P105	100	105X80	80/77x60	9	40	125		75
A510 434G L125R P105	125	105X80	80/77x60	9	40	155		100
A510 434G L160R P135	160	135X110	105x84/76	11	55	195		135
A510 434G L200R P135	200	135X110	105x84/76	11	55	235		205



Bockrolle							
	mm	mm	mm	mm	mm	mm	Kg
A510 434G B080R P105	080	105X80	80/77x60	9		105	70
A510 434G B100R P105	100	105X80	80/77x60	9		125	75
A510 434G B125R P105	125	105X80	80/77x60	9		155	100
A510 434G B160R P135	160	135X110	105x84/76	11		195	135
A510 434G B200R P135	200	135X110	105x84/76	11		235	205





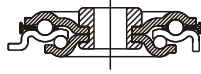

Lenkrolle mit Total-Feststeller								
	mm	mm	mm	mm	mm	mm	mm	Kg
A510 434G L080R P105F	080	105X80	80/77x60	9	40	105	127	70
A510 434G L100R P105F	100	105X80	80/77x60	9	40	125	127	75
A510 434G L125R P105F	125	105X80	80/77x60	9	45	155	127	100
A510 434G L160R P135F	160	135X110	105x84/76	11	55	195	165	135
A510 434G L200R P135F	200	135X110	105x84/76	11	55	235	165	205

# Transportgeräterollen Basics Serie A510 434...









Radfelge: Stahlblech  
 Lauffläche: Vollgummi grau 85° Shore A  
 Lager: Rollenlager  
 Fadenschutz: ohne  
 Traglast: 70kg bis 205kg  
 Raddurchmesser: 80mm bis 200mm  
 Temperaturbereich: -20°C bis +60°C









Rückenlochenkrolle					
	mm	mm	mm	mm	Kg
A510 434 L080R RL13	080	13	40	104	70
A510 434 L100R RL13	100	13	40	124	75
A510 434 L125R RL13	125	13	40	154	100
A510 434 L160R RL13	160	13	55	189	135
A510 434 L200R RL13	200	13	55	228	205



Rückenlochenkrolle mit Total-Feststeller						
	mm	mm	mm	mm	mm	Kg
A510 434G L080R RL13F	080	13	40	104	127	70
A510 434G L100R RL13F	100	13	40	124	127	75
A510 434G L125R RL13F	125	13	45	154	127	100
A510 434G L160R RL13F	160	13	55	189	165	135
A510 434G L200R RL13F	200	13	55	228	165	205



Einbaurad mit Achsmaterial						
	mm	mm	mm	mm	Ø	Kg
B415 434G 080R RL12	080	27	40	12	M8	70
B415 434G 100R RL12	100	27	40	12	M8	75
B415 434G 125R RL12	125	38	50	12	M8 M10	100
B415 434G 160R RL12	160	40	59	20	M12	135
B415 434G 200R RL12	200	50	59	20	M12	205

# Transportgeräterollen Premium Serie A454 434G...

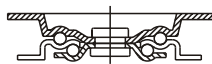

Radfelge: Aluminium  
 Lauffläche: Vollgummi grau 65° Shore A  
 Lager: Doppelkugellager  
 Fadenschutz: ohne  
 Traglast: 200kg bis 250kg  
 Raddurchmesser: 100mm bis 125mm  
 Temperaturbereich: -20°C bis +85°C



Lenkrolle								
	mm	mm	mm	mm	mm	mm	mm	Kg
A514 434G L100K P105		100	105X80	80/77x60	9	40	128	200
A514 434G L100K P135		100	135X110	105x84/76	11	50	128	200
A514 434G L125K P135		125	105X80	80/77x60	9	40	155	250
A514 434G L125K P135		125	135X110	105x84/76	11	50	155	250



Bockrolle							
	mm	mm	mm	mm	mm	mm	Kg
A514 434G B100K P105		100	105X80	80/77x60	9	128	200
A514 434G B100K P135		100	135X110	105x84/76	11	128	200
A514 434G B125K P105		125	105X80	80/77x60	9	155	250
A514 434G B125K P135		125	135X110	105x84/76	11	155	250



Lenkrolle mit Total-Feststeller									
	mm	mm	mm	mm	mm	mm	mm	mm	Kg
A514 434G L100K P105F		100	105X80	80/77x60	9	40	128	127	200
A514 434G L100K P135F		100	135X110	105x84/76	11	55	128	154	200
A514 434G L125K P105F		125	105X80	80/77x60	9	45	155	127	250
A514 434G L125K P135F		125	135X110	105x84/76	11	55	155	154	250



Einbaurad mit Achsmaterial							
	mm	mm	mm	mm	Ø	Kg	
B445 434G 100K RL12		100	40	40	12	M8	200
B445 434G 125K RL15		125	40	50	15	M10	250

# Transportgeräterollen Premium Serie A515 434...

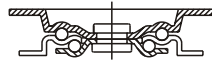

Radfelge: Aluminium  
 Lauffläche: Polyurethan braun 92° Shore A  
 Lager: Doppelkugellager  
 Fadenschutz: ohne  
 Traglast: 250kg bis 300kg  
 Raddurchmesser: 100mm bis 125mm  
 Temperaturbereich: -20°C bis +60°C



Lenkrolle								
	mm	mm	mm	mm	mm	mm	mm	Kg
A515 434 L100K P105		100	105X80	80/77x60	9	40	128	250
A515 434 L100K P135		100	135X110	105x84/76	11	50	128	250
A515 434 L125K P105		125	105X80	80/77x60	9	40	155	300
A515 434 L125K P135		125	135X110	105x84/76	11	50	155	300



Bockrolle							
	mm	mm	mm	mm	mm	mm	Kg
A515 434 B100K P105		100	105X80	80/77x60	9	128	250
A515 434 B100K P135		100	135X110	105x84/76	11	128	250
A515 434 B125K P105		125	105X80	80/77x60	9	155	300
A515 434 B125K P135		125	135X110	105x84/76	11	155	300



Lenkrolle mit Total-Feststeller									
	mm	mm	mm	mm	mm	mm	mm	Kg	
A515 434 L100K P105F		100	105X80	80/77x60	9	40	128	127	250
A515 434 L100K P135F		100	135X110	105x84/76	11	55	128	154	250
A515 434 L125K P105F		125	105X80	80/77x60	9	45	155	127	300
A515 434 L125K P135F		125	135X110	105x84/76	11	55	155	154	300



Einbaurad mit Achsmaterial							
	mm	mm	mm	mm	Ø	Kg	
B447 434 100x40 K12		100	40	40	12	M8	250
B447 434 125x50 K15		125	40	50	15	M10	300



## Schwerlastrollen



Schwere Lasten? Kein Problem mit unseren Rollen. Mit einer Tragfähigkeit von bis zu 1.000kg bewegen unsere Rollen Ihre Ware an den Bestimmungsort, sicher und schnell.

# Schwerlastrollen Serie A515 434...

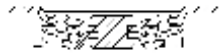

Radfelge: Aluminium  
 Lauffläche: Polyurethan 93 -95° Shore A  
 Lager: 6204 Doppelprezisionskugellager  
 Fadenschutz: ohne  
 Traglast: 400kg bis 600kg  
 Raddurchmesser: 125mm bis 200mm  
 Temperaturbereich: -20°C bis +60°C



Lenkrolle								
	mm	mm	mm	mm	mm	mm	mm	Kg
A515 434 LV125K P105		125	135X110	105x84/76	11	50	164	400
A515 434 LV160K P135		160	135X110	105x84/76	11	55	195	500
A515 434 LV200K P105		200	135X110	105x84/76	11	55	245	600



Bockrolle							
	mm	mm	mm	mm	mm	mm	Kg
A515 434 BV125K P105		125	135X110	105x84/76	11	164	400
A515 434 BV160K P135		160	135X110	105x84/76	11	195	500
A515 434 BV200K P105		200	135X110	105x84/76	11	245	600



Lenkrolle mit Total-Feststeller								
	mm	mm	mm	mm	mm	mm	mm	Kg
A515 434 LV125K P105F		125	135X110	105x84/76	11	55	164 155	400
A515 434 LV160K P135F		160	135X110	105x84/76	11	55	195 165	500
A515 434 LV200K P105F		200	135X110	105x84/76	11	55	245 165	600



Einbaurad mit Achsmaterial							
	mm	mm	mm	mm	Ø	Kg	
B447 434 BV125x50 K20		125	50	60	20	M12	500
B447 434 BV160x50 K20		160	50	60	20	M12	600
B447 434 BV125x50 K20		200	50	60	20	M12	800

# Schwerlastrollen Serie A514 434G...



Radfelge: Aluminium  
 Lauffläche: Elastik 70° Shore A, grau  
 Lager: 6204 Doppelpräzisionskugellager  
 Fadenschutz: ohne  
 Traglast: 300kg bis 450kg  
 Raddurchmesser: 125mm bis 200mm  
 Temperaturbereich: -20°C bis +80°C

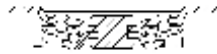

Lenkrolle								
	mm	mm	mm	mm	mm	mm	Kg	
A515 434G L125Kx50 P135		125	135X110	105x84/76	11	50	164	300
A515 434G L160Kx55 P135		160	135X110	105x84/76	11	55	195	350
A515 434G L200Kx55 P135		200	135X110	105x84/76	11	55	245	450



Bockrolle							
	mm	mm	mm	mm	mm	mm	Kg
A515 434G B125K P135		125	135X110	105x84/76	11	164	300
A515 434G B160K P135		160	135X110	105x84/76	11	195	350
A515 434G B200K P135		200	135X110	105x84/76	11	245	450



Lenkrolle mit Total-Feststeller								
	mm	mm	mm	mm	mm	mm	mm	Kg
A515 434G L125Kx50 P135F		125	135X110	105x84/76	11	55	164 155	300
A515 434G L160Kx55 P135F		160	135X110	105x84/76	11	55	195 165	350
A515 434G L200Kx55 P135F		200	135X110	105x84/76	11	55	245 165	450



Einbaurad mit Achsmaterial							
	mm	mm	mm	mm	Ø	Kg	
B445 434G 125x50 K20		125	50	60	20	M12	300
B445 434G 160x50 K20		160	50	60	20	M12	400
B445 434G 200x50 K20		200	50	60	20	M12	500



# Schwerlastrollen Serie A506 434...



Radfelge: Polyamid PA 6, weiß  
 Lauffläche: Polyamid PA 6, weiß  
 Lager: 6204 Doppelprezisionskugellager  
 Fadenschutz: ohne  
 Traglast: 800kg bis 1000kg  
 Raddurchmesser: 150mm bis 200mm  
 Temperaturbereich: -40°C bis +80°C



Lenkrolle								
	mm	mm	mm	mm	mm	mm	mm	Kg
A506 434 L150K P135		150	135X110	105x84/76	11	55	197	800
A506 434 L160K P135		160	135X110	105x84/76	11	55	202	800
A506 434 L200K P135		200	135X110	105x84/76	11	55	245	1000



Bockrolle							
	mm	mm	mm	mm	mm	mm	Kg
A506 434 B150K P135		150	135X110	105x84/76	11	197	800
A506 434 B160K P135		160	135X110	105x84/76	11	202	800
A506 434 B200K P135		200	135X110	105x84/76	11	245	1000



Lenkrolle mit Total-Feststeller									
	mm	mm	mm	mm	mm	mm	mm	Kg	
A506 434 L150K P135F		150	135X110	105x84/76	11	55	197	165	800
A506 434 L160K P135F		160	135X110	105x84/76	11	55	202	195	800
A506 434 L200K P135F		200	135X110	105x84/76	11	55	245	195	1000



Einbaurad mit Achsmaterial							
	mm	mm	mm	mm	Ø	Kg	
B640 434 150x50 K20		150	50	60	20	M12	800
B640 434 160x50 K20		160	50	60	20	M12	800
B640 434 200x50 K20		200	50	60	20	M12	1000

# Schwerlastrollen Serie A544 434G...



Radfelge: Aluminium  
 Lauffläche: Elastik 70° Shore A, grau  
 Lager: 6204 Doppelpräzisionskugellager  
 Fadenschutz: ohne  
 Traglast: 300kg bis 500kg  
 Raddurchmesser: 125mm bis 200mm  
 Temperaturbereich: -20°C bis +80°C



Lenkrolle							
	mm	mm	mm	mm	mm	mm	Kg
A544 434G L125K P135	125	135X110	105x84/76	11	54	170	300
A544 434G L160K P135	160	135X110	105x84/76	11	55	202	400
A544 434G L200K P135	200	135X110	105x84/76	11	55	245	500



Bockrolle						
	mm	mm	mm	mm	mm	Kg
A544 434G B125K P135	125	135X110	105x84/76	11	170	300
A544 434G B160K P135	160	135X110	105x84/76	11	202	400
A544 434G B200K P135	200	135X110	105x84/76	11	245	500



Lenkrolle mit Total-Feststeller								
	mm	mm	mm	mm	mm	mm	mm	Kg
A544 434G L125K P135F	125	135X110	105x84/76	11	54	170	165	300
A544 434G L160K P135F	160	135X110	105x84/76	11	55	202	195	400
A544 434G L200K P135F	200	135X110	105x84/76	11	55	245	195	500

# Schwerlastrollen Serie A516 434B...

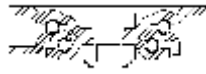

Radfelge: Aluminium  
 Lauffläche: Polyurethan 93 -95° Shore A  
 Lager: 6204 Doppelprezisionskugellager  
 Fadenschutz: ohne  
 Traglast: 500kg bis 800kg  
 Raddurchmesser: 125mm bis 200mm  
 Temperaturbereich: -20°C bis +60°C



Lenkrolle								
	mm	mm	mm	mm	mm	mm	mm	Kg
A516 434B L125K P135		125	135X110	105x84/76	11	54	170	500
A516 434B L160K P135		160	135X110	105x84/76	11	55	202	600
A516 434B L200K P135		200	135X110	105x84/76	11	55	245	800



Bockrolle								
	mm	mm	mm	mm	mm	mm	mm	Kg
A516 434B B125K P135		125	135X110	105x84/76	11		170	500
A516 434B B160K P135		160	135X110	105x84/76	11		202	600
A516 434B B200K P135		200	135X110	105x84/76	11		245	800



Lenkrolle mit Total-Feststeller									
	mm	mm	mm	mm	mm	mm	mm	mm	Kg
A516 434B L125K P135F		125	135X110	105x84/76	11	54	170	165	500
A516 434B L160K P135F		160	135X110	105x84/76	11	55	202	195	600
A516 434B L200K P135F		200	135X110	105x84/76	11	55	245	195	800

# Schwerlastrollen Serie A516 434G...

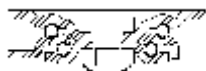

Radfelge: Aluminium  
 Lauffläche: PULastic 75° Shore A, grün  
 Lager: 6204 Doppelpräzisionskugellager  
 Fadenschutz: ohne  
 Traglast: 500kg bis 800kg  
 Raddurchmesser: 125mm bis 200mm  
 Temperaturbereich: -20°C bis +60°C



Lenkrolle								
	mm	mm	mm	mm	mm	mm	mm	Kg
A516 434 PUL125K P135		125	135X110	105x84/76	11	54	170	500
A516 434 PUL160K P135		160	135X110	105x84/76	11	55	202	600
A516 434 PUL200K P135		200	135X110	105x84/76	11	55	245	800



Bockrolle							
	mm	mm	mm	mm	mm	mm	Kg
A516 434 PUB125K P135		125	135X110	105x84/76	11	170	500
A516 434 PUB160K P135		160	135X110	105x84/76	11	202	600
A516 434 PUB200K P135		200	135X110	105x84/76	11	245	800



Lenkrolle mit Total-Feststeller									
	mm	mm	mm	mm	mm	mm	mm	Kg	
A516 434 PUL125K P135F		125	135X110	105x84/76	11	54	170	165	500
A516 434 PUL160K P135F		160	135X110	105x84/76	11	55	202	195	600
A516 434 PUL200K P135F		200	135X110	105x84/76	11	55	245	195	800



Einbaurad mit Achsmaterial							
	mm	mm	mm	mm	Ø	Kg	
B447 434 PUL125x50 K20		125	50	60	20	M12	500
B447 434 PUL160x50 K20		160	50	60	20	M12	600
B447 434 PUL160x50 K20		200	50	60	20	M12	800

# Schwerlastrollen Geschweißte Ausführung Serie A575 434R...



Radfelge: Aluminium  
 Lauffläche: Polyurethan 93 -95° Shore A, orange  
 Lager: 6204 Doppelprezisionskugellager  
 Fadenschutz: ohne  
 Traglast: 500kg bis 800kg  
 Raddurchmesser: 125mm bis 200mm  
 Temperaturbereich: -20°C bis +60°C



Lenkrolle								
	mm	mm	mm	mm	mm	mm	mm	Kg
A575 434R L125K P135	125	135X110	105x84/76	11	50	170		500
A575 434R L160K P135	160	135X110	105x84/76	11	57	202		600
A575 434R L200K P135	200	135X110	105x84/76	11	59	245		800



Bockrolle							
	mm	mm	mm	mm	mm	mm	Kg
A575 434R B125K P135	125	135X110	105x84/76	11	170		500
A575 434R B160K P135	160	135X110	105x84/76	11	202		600
A575 434R B200K P135	200	135X110	105x84/76	11	245		800



Lenkrolle mit Feststeller								
	mm	mm	mm	mm	mm	mm	mm	Kg
A575 434R L125K P135F	125	135X110	105x84/76	11	50	170	112.5	500
A575 434R L160K P135F	160	135X110	105x84/76	11	57	202	137	600
A575 434R L200K P135F	200	135X110	105x84/76	11	59	245	159	800

# Schwerlastrollen Geschweißte Ausführung Serie A575 434G...



Radfelge: Aluminium  
 Lauffläche: PUlastic 75° Shore A, grün  
 Lager: 6204 Doppelpräzisionskugellager  
 Fadenschutz: ohne  
 Traglast: 500kg bis 800kg  
 Raddurchmesser: 125mm bis 200mm  
 Temperaturbereich: -20°C bis +60°C



Lenkrolle								
	mm	mm	mm	mm	mm	mm	mm	Kg
A575 434G L125K P135		125	135X110	105x84/76	11	50	170	500
A575 434G L160K P135		160	135X110	105x84/76	11	57	202	600
A575 434G L200K P135		200	135X110	105x84/76	11	59	245	800



Bockrolle							
	mm	mm	mm	mm	mm	Kg	
A575 434G B125K P135		125	135X110	105x84/76	11	170	500
A575 434G B160K P135		160	135X110	105x84/76	11	202	600
A575 434G B200K P135		200	135X110	105x84/76	11	245	800



Lenkrolle mit Feststeller									
	mm	mm	mm	mm	mm	mm	mm	Kg	
A575 434G L125K P135F		125	135X110	105x84/76	11	50	170	112.5	500
A575 434G L160K P135F		160	135X110	105x84/76	11	57	202	137	600
A575 434G L200K P135F		200	135X110	105x84/76	11	59	245	159	800

# Schwerlastrollen Geschweißte Ausführung Serie A560 434...



Radfelge: Polyamid PA 6, weiß  
 Lauffläche: Polyamid PA 6, weiß  
 Lager: 6204 Doppelprezisionskugellager  
 Fadenschutz: ohne  
 Traglast: 800kg bis 1000kg  
 Raddurchmesser: 150mm bis 200mm  
 Temperaturbereich: -40°C bis +80°C



Lenkrolle								
	mm	mm	mm	mm	mm	mm	mm	Kg
A560 434 L150K P135		150	135X110	105x84/76	11	57	197	800
A560 434 L160K P135		160	135X110	105x84/76	11	57	202	800
A560 434 L200K P135		200	135X110	105x84/76	11	59	245	1000



Bockrolle							
	mm	mm	mm	mm	mm	mm	Kg
A560 434 B150K P135		150	135X110	105x84/76	11	197	800
A560 434 B160K P135		160	135X110	105x84/76	11	202	800
A560 434 B200K P135		200	135X110	105x84/76	11	245	1000



Lenkrolle mit Feststeller									
	mm	mm	mm	mm	mm	mm	mm	Kg	
A560 434 L150K P135F		150	135X110	105x84/76	11	57	197	132	800
A560 434 L160K P135F		160	135X110	105x84/76	11	57	202	137	800
A560 434 L200K P135F		200	135X110	105x84/76	11	59	245	159	1000



Einbauroad mit Achsmaterial							
	mm	mm	mm	mm	mm	Ø	Kg
B640 434 L150K RL20		150	50	60	20	M12	800
B640 434 L160K RL20		160	50	60	20	M12	800
B640 434 L200K RL20		200	50	60	20	M12	1000

# Schwerlastrollen Geschweißte Ausführung Serie A588 434...



Radfelge: Gussfelge  
 Lauffläche: Polyurethan 93° Shore A, braun  
 Lager: 6204 Doppelpräzisionskugellager  
 Fadenschutz: ohne  
 Traglast: 700kg bis 1000kg  
 Raddurchmesser: 125mm bis 200mm  
 Temperaturbereich: -20°C bis +80°C



Lenkrolle								
	mm	mm	mm	mm	mm	mm	mm	Kg
A588 434 L125K P135		125	135X110	105x84/76	11	50	170	700
A588 434 L160K P135		160	135X110	105x84/76	11	57	202	800
A588 434 L200K P135		200	135X110	105x84/76	11	59	245	1000



Bockrolle							
	mm	mm	mm	mm	mm	mm	Kg
A588 434 B125K P135		125	135X110	105x84/76	11	170	700
A588 434 B160K P135		160	135X110	105x84/76	11	202	800
A588 434 B200K P135		200	135X110	105x84/76	11	245	1000



Lenkrolle mit Feststeller									
	mm	mm	mm	mm	mm	mm	mm	mm	Kg
A588 434 L125K P135F		125	135X110	105x84/76	11	50	170	112.5	700
A588 434 L160K P135F		160	135X110	105x84/76	11	57	202	137	800
A588 434 L200K P135F		200	135X110	105x84/76	11	59	245	159	1000





## Edelstahlrollen



Ärgern Sie sich über schlecht rollende, rostige Rollen? Wechseln Sie zu den neuen Edelstahlrollen. Diese haben nicht nur legendäre Laufeigenschaften, sondern passen auch perfekt zu ihrer Ausrüstung.

# Edelstahlrollen Innovation Serie A502 434...

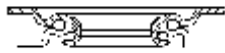

Radfelge: Polyamid  
 Lauffläche: Polyamid  
 Lager: Edelstahl Gleitlager  
 Fadenschutz: ohne  
 Traglast: 130kg bis 200kg  
 Raddurchmesser: 80mm bis 125mm  
 Temperaturbereich: -40°C bis +80°C



Lenkrolle								
	mm	mm	mm	mm	mm	mm	mm	Kg
A502 434 L080G P096	80	96X80	80/77x60	9	36	108		130
A502 434 L100G P096	100	96X80	80/77x60	9	36	128		150
A502 434 L125G P096	125	96X80	80/77x60	9	36	155		200



Bockrolle							
	mm	mm	mm	mm	mm	mm	Kg
A502 434 B080G P096	80	96X80	80/77x60	9		108	130
A502 434 B100G P096	100	96X80	80/77x60	9		128	150
A502 434 B125G P096	125	96X80	80/77x60	9		155	200





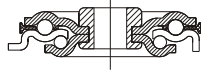

Lenkrolle mit Total-Feststeller									
	mm	mm	mm	mm	mm	mm	mm	mm	Kg
A502 434 L080G P096F	80	96X80	80/77x60	9	36	108	115		130
A502 434 L100G P096F	100	96X80	80/77x60	9	36	128	115		150
A502 434 L125G P096F	125	96X80	80/77x60	9	45	155	120		200

## Edelstahlrollen Innovation Serie A502 434...









Radfelge: Polyamid  
 Lauffläche: Polyamid  
 Lager: Edelstahl Gleitlager  
 Fadenschutz: ohne  
 Traglast: 130kg bis 200kg  
 Raddurchmesser: 80mm bis 125mm  
 Temperaturbereich: -40°C bis +80°C



Rückenlochlenkrolle					
	mm	mm	mm	mm	Kg
A502 434 L080G RL13	080	13	36	106	130
A502 434 L100G RL13	100	13	36	126	150
A502 434 L125G RL13	125	13	40	153	200



Rückenlochlenkrolle mit Total-Feststeller						
	mm	mm	mm	mm	mm	Kg
A502 434 L080G RL13F	080	13	36	106	115	130
A502 434 L100G RL13F	100	13	36	126	115	150
A502 434 L125G RL13F	125	13	45	153	120	200

# Edelstahlrollen Innovation Serie A503 434...

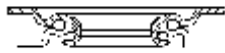

Radfelge: Polyamid  
 Lauffläche: Thermopl. Polyurethan 95° Shore A  
 Lager: Edelstahl Rollenlager  
 Fadenschutz: ohne  
 Traglast: 130kg bis 200kg  
 Raddurchmesser: 80mm bis 125mm  
 Temperaturbereich: -40°C bis +80°C



Lenkrolle							
	mm	mm	mm	mm	mm	mm	Kg
A503 434 L080G P096	080	96X80	80/77x60	9	36	108	130
A503 434 L100G P096	100	96X80	80/77x60	9	36	128	150
A503 434 L125G P096	125	96X80	80/77x60	9	36	155	200



Bockrolle							
	mm	mm	mm	mm	mm	mm	Kg
A503 434 B080G P096	080	96X80	80/77x60	9		108	130
A503 434 B100G P096	100	96X80	80/77x60	9		128	150
A503 434 B125G P096	125	96X80	80/77x60	9		155	200





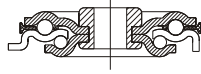

Lenkrolle mit Total-Feststeller								
	mm	mm	mm	mm	mm	mm	mm	Kg
A503 434 L080G P096F	080	96X80	80/77x60	9	36	108	115	130
A503 434 L100G P096F	100	96X80	80/77x60	9	36	128	115	150
A503 434 L125G P096F	125	96X80	80/77x60	9	36	155	120	200

# Edelstahlrollen Innovation Serie A503 434...









Radfelge: Polyamid  
 Lauffläche: Thermopl. Polyurethan 95° Shore A  
 Lager: Edelstahl Rollenlager  
 Fadenschutz: ohne  
 Traglast: 130kg bis 200kg  
 Raddurchmesser: 80mm bis 125mm  
 Temperaturbereich: -40°C bis +80°C



Rückenlochlenkrolle					
	mm	mm	mm	mm	Kg
A503 434 L080G RL13	080	13	36	106	130
A503 434 L100G RL13	100	13	36	126	150
A503 434 L125G RL13	125	13	40	153	200



Rückenlochlenkrolle mit Total-Feststeller						
	mm	mm	mm	mm	mm	Kg
A503 434 L080G RL13F	080	13	40	106	115	130
A503 434 L100G RL13F	100	13	40	126	115	150
A503 434 L125G RL13F	125	13	45	153	120	200

# Edelstahlrollen Innovation Serie

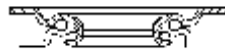

Radfelge: Polyamid  
 Lauffläche: Elastik grau 65° Shore A  
 Lager: Edelstahl (Rollenlager/ mittiges Kugellager)  
 Fadenschutz: ohne/ kleiner Kunststoff Fadenschutz  
 Traglast: 150kg bis 200kg  
 Raddurchmesser: 100mm bis 125mm  
 Temperaturbereich: -20°C bis +80°C



Lenkrolle								
	mm	mm	mm	mm	mm	mm	mm	Kg
A502 434 L100G P096 A502 434 L100K P096		100	96X80	80/77x60	9	36	128	160
A502 434 L125G P096 A502 434 L125K P096		125	96X80	80/77x60	9	40	155	200



Bockrolle							
	mm	mm	mm	mm	mm	mm	Kg
A502 434 B100G P096 A502 434 B100K P096		100	96X80	80/77x60	9	128	160
A502 434 B125G P096 A502 434 B125K P096		125	96X80	80/77x60	9	155	200







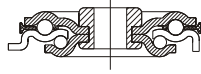

Lenkrolle mit Total-Feststeller									
	mm	mm	mm	mm	mm	mm	mm	Kg	
A502 434 L100G P096F A502 434 L100K P096F		100	96X80	80/77x60	9	36	128	115	160
A502 434 L125G P096F A502 434 L125K P096F		125	96X80	80/77x60	9	40	155	120	200

# Edelstahlrollen Innovation Serie A501 434...











Radfelge: Polyamid  
 Lauffläche: Elastik grau 65° Shore A  
 Lager: Edelstahl (Rollenlager/ mittiges Kugellager)  
 Fadenschutz: ohne/ kleiner Kunststoff Fadenschutz  
 Traglast: 150kg bis 200kg  
 Raddurchmesser: 100mm bis 125mm  
 Temperaturbereich: -20°C bis +80°C



Rückenlochlenkrolle						
	mm	mm	mm	mm	Kg	
A502 434 L100G RL13 A502 434 L100K RL13		100	13	36	126	150
A502 434 L125G RL13 A502 434 L125K RL13		125	13	40	153	150



Rückenlochlenkrolle mit Total-Feststeller							
	mm	mm	mm	mm	mm	Kg	
A502 434 L100G RL13F A502 434 L100K RL13F		100	13	36	126	115	150
A502 434 L125G RL13F A502 434 L125K RL13F		125	13	40	153	120	150



## Müllbehälterrollen



Transport von Abfällen erfordert starke Rollen- und keine Abfallprodukte. Leichtlaufende Rollen sind für die Bewegung von großen und schweren Behältern wichtig.



# Müllbehälterrollen Serie A510 434 M...

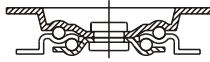

Radfelge: Polypropylen  
 Lauffläche: Vollgummi schwarz 85° Shore A  
 Lager: Nylon Gleitlager  
 Fadenschutz: Ohne  
 Traglast: 175kg bis 205kg  
 Raddurchmesser: 160mm bis 200mm  
 Temperaturbereich: -20°C bis +60°C



Lenkrolle	mm	mm	mm	mm	mm	mm	Kg
A510 434 ML160 P135	160	135X110	105x84/76	11	52	195	175
A510 434 ML200 P135	200	135X110	105x84/76	11	55	238	205



Lenkrolle Feststeller mit Schraube	mm	mm	mm	mm	mm	mm	Kg
A510 434 ML160 P135F	160	135X110	105x84/76	11	52	195	175
A510 434 ML200 P135F	200	135X110	105x84/76	11	55	238	205









Einbaurad mit Achsmaterial	mm	mm	mm	mm	Ø	Kg
B415 434 M200 K20/M12	160	50	60	20	M12	175
B415 434 M160 K20/M12	200	50	60	20	M12	205

# Müllbehälterrollen Serie ZUB 434...



Radfelge: Polypropylen  
 Lauffläche: Vollgummi schwarz 85° Shore A  
 Traglast: 100kg  
 Raddurchmesser: 200mm  
 Temperaturbereich: -20°C bis +60°C





Rad für Mülltonnen	 mm	 mm	 mm	 mm	 Ø	 Kg
ZUB 44 M200G	200	50				100





Achse aus Vollmaterial für Mülltonnen	 mm
ZUB 434 A460SO	460
ZUB 434 A552SO	552



halb-hohle Achse für Mülltonnen	 mm	 mm
ZUB 434 A460SE20	460	2.0
ZUB 434 A552SE20	552	2.0



hohle Achse für Mülltonnen	 mm	 mm
ZUB 434 A460H018	460	1.8
ZUB 434 A552H018	552	
ZUB 434 A460H025	460	2.5
ZUB 434 A552H025	552	



Ihr zuverlässiger Partner in Sachen  
Transport-, Förder- und Rollentechnik



Roritzerstraße 32 ~ D-90419 Nürnberg  
Tel. 0911 - 33 15 08 ~ Fax 0911 - 33 81 38  
E-Mail: [service@burkhardt-rollen.de](mailto:service@burkhardt-rollen.de) ~ [www.burkhardt-rollen.de](http://www.burkhardt-rollen.de)

